

# Janssen®

**PIANO ACCESSORIES**

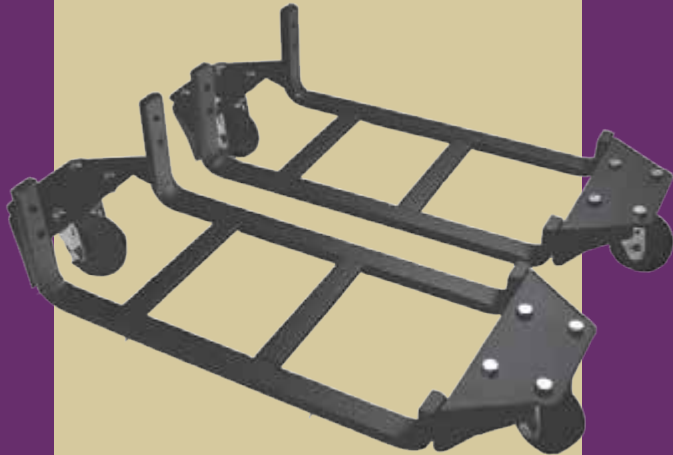

*Piano Covers*



*Vertical Piano Dolly*

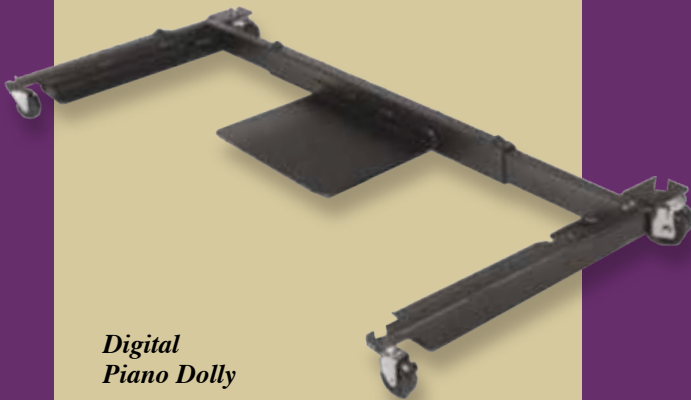

*Digital  
Piano Dolly*

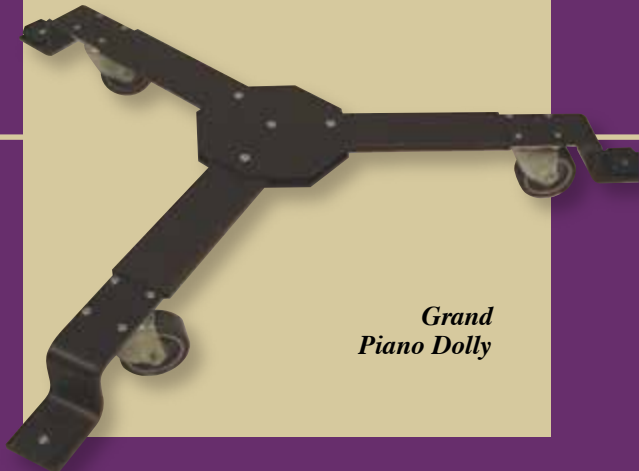

*Grand  
Piano Dolly*

**A Tradition of Craftsmanship  
for over 50 years**

**YOUR CUSTOMER NUMBER IS:**

PHONE #1-800-236-2437

FAX # 1-920-231-5450

EMAIL: [customerservice@pljansen.com](mailto:customerservice@pljansen.com)

WEBSITE: [www.pljansen.com](http://www.pljansen.com)

Office Hours: 8:00 AM-5:00 PM

Central Standard Time

Monday-Friday

## BENCHES

Artist Bench Leg Styles .....	2
Artist Benches .....	3
Artist Bench w/ Compartment .....	9
Artist Bench Repair Kit .....	19
Digital Benches .....	7
Grand Bench Leg Styles .....	4
Grand Benches .....	5
Imported Benches .....	9
Organ Benches .....	7
Petite Duet Artist Benches .....	8
School (Stretcher) Benches .....	8
Upright Bench Leg Styles .....	6
Upright Benches .....	7

## STOOLS / MUSIC CABINET

Piano Stools .....	10
Sheet Music Cabinet .....	8

## ACCESSORIES

Bench Pads .....	11
Caster Cups .....	12-13
Cory Keyboard Products .....	14-15
Fallboard Locks .....	17
Grand Piano Floor Template .....	18
Metronomes .....	16
Quiet Keys .....	18
Save-A-Rug (Deluxe & Rubber) .....	17
Shop and Showroom Dollies .....	19
Soundboard Cleaner/Duster .....	18

## DOLLIES

Digital Dollies .....	20
Grand – Adjustable Dollies .....	21
Grand Leg Dollies .....	21
Spinet & Console Dollies .....	22
Upright Dollies .....	22

## COVERS

Digital (Mackintosh or Vinyl) .....	24
Grand (Mackintosh or Vinyl) .....	24
Grand (Padded) .....	25
Organ (Mackintosh) .....	23
Organ (Padded) .....	25
Upright (Mackintosh) .....	23
Upright (Padded) .....	25

## DAMPP CHASER® PRODUCTS

Grand Dampp Chaser® Systems .....	27
Vertical Dampp Chaser® Systems .....	26
Humidifier Treatment .....	27
Hygrometers .....	26
Replacement Pads .....	27

## MOVING EQUIPMENT

Digital Piano Dolly .....	30
Dual Trucks .....	28
Grand Transporter .....	29
Moving Pads .....	31
Piano Moving Dolly .....	30
Skidboards .....	31
Web Straps .....	31

## LIFTING EQUIPMENT

Grand Leg Stand .....	32
Jack-in-the-Box .....	32
Piano Lifting Bars .....	32

## FAX ORDER FORM .....

## PRICING .....

Rear of Catalog

# JANSEN®

PAUL L. JANSEN & SON®

1550 Harrison Street • Oshkosh, WI 54901-3008 • 1-920-231-5433 • 1-800-BENCHES  
1-800-236-2437 • FAX 1-920-231-5450 • WEBSITE pljansen.com • EMAIL Customerservice@pljansen.com

# ARTIST BENCH LEG STYLE OPTIONS



**J-1**  
Round



**J-2**  
Brass  
Ferrule



**J-3**  
Spade



**J-4**  
Straight  
Tapered



**J-5**  
Queen Anne  
(Straight On and Profile)



**J-6**  
Reeded



**J-7**  
Louis XV



**J-8**  
Fluted



**J-9**  
Octagonal

## ***NINE LEG STYLES! GUARANTEED QUALITY!***

Jansen® Artist Benches are available in a variety of leg styles to match your taste and furniture décor. We continually add more style options to satisfy the needs of our valued customers.

## ***SO MANY WAYS TO ORDER!***

Call us at 1-800-BENCHES with any questions you have or e-mail your order to: [customerservice@pljansen.com](mailto:customerservice@pljansen.com). If you prefer, you may use the convenient fax order form at the back of this catalog, or visit our website at [www.pljansen.com](http://www.pljansen.com).

# JANSEN®

PAUL L. JANSEN & SON®

1550 Harrison Street • Oshkosh, WI 54901-3008 • 1-920-231-5433 • 1-800-BENCHES  
1-800-236-2437 • FAX 1-920-231-5450 • WEBSITE [pljansen.com](http://pljansen.com) • EMAIL [Customerservice@pljansen.com](mailto:Customerservice@pljansen.com)

# ARTIST BENCHES



## STANDARD SIZE

Size: 16 1/2" x 21 1/2"  
Adjusts from approximately 18" to 21"  
(Shown in Ebony satin)

Features diamond tufted vinyl top upholstery.  
Nine leg styles available.

**Finishes Available:** Ebony, Walnut, Mahogany, and Unfinished.

**Options (additional cost):** Hi-Polish, White or Ivory Finish,  
Leather upholstery and Pneumatic Mechanism



## PETITE SIZE

Size: 13" x 21"  
Adjusts from approximately 18" to 21"  
(Shown in Mahogany satin)

Features the same adjustable mechanism used in the standard size artist bench. This smaller size bench is ideally suited for smaller grand pianos, vertical pianos, and in practice rooms.

**Finishes Available:** Ebony, Walnut, Mahogany, and Unfinished.

**Options (additional cost):** Hi-Polish, White or Ivory Finish, Leather upholstery

## JANSEN® FINE ARTIST BENCHES BEGIN ON THE INSIDE

Our silent "Micro-A-Just" mechanism features precision, durability and convenience.

Our proven **quality** begins with the material selected. Solid Maple hardwood legs and frame with durable vinyl or optional genuine leather upholstery are featured on every Artist Bench manufactured by Paul L. Jansen and Son®.

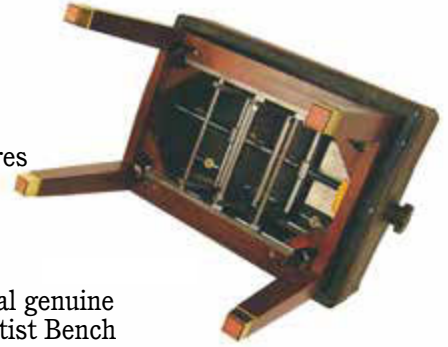

## DUET SIZE

Size: 16 1/2" x 33"  
Adjusts from approximately 18" to 21"  
(Shown in Walnut satin)

Features diamond tufted vinyl top upholstery.  
Nine leg styles available.

**Finishes Available:** Ebony, Walnut, Mahogany, and Unfinished.

**Options (additional cost):** Hi-Polish, White or Ivory Finish, Leather upholstery

## ORDERING HAS NEVER BEEN EASIER

- 1) Simply note **model Number:** J-1, J-2, J-3, J-4, J-5, J-6, J-7, J-8 or J-9. (To view leg styles see opposite page.)
- 2) Select the bench size - Standard, Petite, Duet or Petite Duet (see page 8 for Petite Duet).
- 3) Select the wood finish - Ebony, Walnut, Mahogany, White, Ivory or Unfinished.
- 4) Select - **Satin** or **Hi-Polish**.
- 5) Select upholstery material - **Vinyl** or **Leather**.
- 6) Select upholstery color - Black, Brown, Burgundy, White or Ivory.

**\*\*When ordering mahogany finish with leather, the recommended leather color is burgundy.**

# JANSEN®

PAUL L. JANSEN & SON®

1550 Harrison Street • Oshkosh, WI 54901-3008 • 1-920-231-5433 • 1-800-BENCHES  
1-800-236-2437 • FAX 1-920-231-5450 • WEBSITE pljansen.com • EMAIL Customerservice@pljansen.com

# GRAND BENCH LEG STYLE OPTIONS



**J-585**  
Square Tapered



**J-586**  
Spade



**J-587**  
Brass Ferrule



**J-588**  
Round Tapered



**J-589**  
Queen Anne



**J-590**  
Round Reeded



**J-591**  
Round Fluted



**J-592**  
Early American



**J-593**  
Octagonal



**J-594**  
Louis XV

## CHOOSE THE LEG STYLE THAT MATCHES YOUR PIANO

Jansen® Grand Benches feature either wood or upholstered tops and are available in ten leg options to match your piano.

Call us at 1-800-BENCHES with any questions you have or e-mail your order to: [customerservice@pljansen.com](mailto:customerservice@pljansen.com). If you prefer, you may use the convenient fax order form at the back of this catalog, or visit our website at [www.pljansen.com](http://www.pljansen.com).

# JANSEN®

PAUL L. JANSEN & SON®

1550 Harrison Street • Oshkosh, WI 54901-3008 • 1-920-231-5433 • 1-800-BENCHES  
1-800-236-2437 • FAX 1-920-231-5450 • WEBSITE [pljansen.com](http://pljansen.com) • EMAIL [Customerservice@pljansen.com](mailto:Customerservice@pljansen.com)



# GRAND BENCHES



**WOOD TOP**  
(Shown in Walnut Satin)

- J-585 Square Tapered
- J-586 Spade Foot
- J-587 Brass Ferrule
- J-588 Round Tapered
- J-589 Queen Anne
- J-590 Round Reeded
- J-591 Round Fluted
- J-592 Early American
- J-593 Octagonal
- J-594 Louis XV



**UPHOLSTERED TOP**  
(Shown in Mahogany Satin)

- J-585 UPH Square Tapered
- J-586 UPH Spade Foot
- J-587 UPH Brass Ferrule
- J-588 UPH Round Tapered
- J-589 UPH Queen Anne
- J-590 UPH Round Reeded
- J-591 UPH Round Fluted
- J-592 UPH Early American
- J-593 UPH Octagonal
- J-594 UPH Louis XV

**Size - 14" x 33"**  
**Height - 19"**

Same length as the  
Jansen® Duet Artist  
Bench.

Music Compartment is  
standard in all Grand  
Benches.

The look and feel of quality in the Jansen® Wood top and Upholstered top Grand Bench is the result of our constant attention to detail. All benches are constructed of hardwood Maple. The wood top benches feature a beveled edge. Jansen® Grand benches are available in ten leg styles. *(To view leg styles see opposite page)*

**Finishes Available:** Ebony, Walnut, Mahogany, Unfinished are standard.  
White or Ivory is available at additional cost.

**Options:** Satin finish is standard. Hi-Polish finish is optional at additional cost.

**WHEN ORDERING A GRAND BENCH:**

- (1) Note the **Model Number**
- (2) Specify: **Wood Finish:** Ebony, Walnut, Mahogany, Unfinished, White or Ivory
- (3) Specify: Satin or Hi-Polish
- (4) Specify: **Wood Top or Upholstered Top:** Upholstery colors are Black, Brown, White or Ivory vinyl.

**JANSEN®**

**PAUL L. JANSEN & SON®**

1550 Harrison Street • Oshkosh, WI 54901-3008 • 1-920-231-5433 • 1-800-BENCHES  
1-800-236-2437 • FAX 1-920-231-5450 • WEBSITE pljansen.com • EMAIL Customerservice@pljansen.com

# UPRIGHT BENCH LEG STYLE OPTIONS



Sq. Tapered



Round Tapered



Spade



Brass Ferrule



Queen Anne



Round Reeded



Round Fluted



Early American



Octagonal



Louis XV

## TEN LEG STYLES TO CHOOSE FROM

Jansen® Upright Benches feature ten leg style options to match your piano. They are available in wood or upholstered tops.

Call us at 1-800-BENCHES with any questions you have or e-mail your order to: [customerservice@pljansen.com](mailto:customerservice@pljansen.com). If you prefer, you may use the convenient fax order form at the back of this catalog, or visit our website at [www.pljansen.com](http://www.pljansen.com).

**JANSEN**®  
PAUL L. JANSEN & SON®

1550 Harrison Street • Oshkosh, WI 54901-3008 • 1-920-231-5433 • 1-800-BENCHES  
1-800-236-2437 • FAX 1-920-231-5450 • WEBSITE [pljansen.com](http://pljansen.com) • EMAIL [Customerservice@pljansen.com](mailto:Customerservice@pljansen.com)

## UPRIGHT BENCHES



**WOOD TOP**  
(Shown in Walnut Satin)

- J-501S** Square Tapered (20" High)
- J-501R** Round Tapered (20" High)
- J-501-86** Spade Foot (20" High)
- J-501-87** Brass Ferrule (20" High)
- J-501-89** Queen Anne (19" High)
- J-501-90** Round Reeded (19" High)
- J-501-91** Round Fluted (19" High)
- J-501-92** Early American (19" High)
- J-501-93** Octagonal (19" High)
- J-501-94** Louis XV (19" High)



**UPHOLSTERED TOP**  
(Shown in Mahogany Satin)

- J-500S** Square Tapered (20" High)
- J-500R** Round Tapered (20" High)
- J-500-86** Spade Foot (20" High)
- J-500-87** Brass Ferrule (20" High)
- J-500-89** Queen Anne (19" High)
- J-500-90** Round Reeded (19" High)
- J-500-91** Round Fluted (19" High)
- J-500-92** Early American (19" High)
- J-500-93** Octagonal (19" High)
- J-500-94** Louis XV (19" High)

**Size - 14" x 29"**

Music  
Compartment  
standard in all  
Upright Benches.

All Jansen® Upright Benches are constructed of hardwood Maple and are available in ten leg styles. (To view leg styles see opposite page.) The Wood top bench features a beveled edge.

### WHEN ORDERING AN UPRIGHT, DIGITAL OR ORGAN BENCH:

- (1) Note the **Model Number**
- (2) Specify **Wood Finish:** Ebony, Walnut, Mahogany, and Unfinished are standard. White or Ivory is available at additional cost.
- (3) Specify: Satin finish is standard. Hi-Polish is available at additional cost.
- (4) Specify: **Wood Top or Upholstered Top** (Black, Brown, White or Ivory vinyl.)

## DIGITAL OR ORGAN BENCHES



**DIGITAL BENCH**  
*MODEL J-400*  
Size - 12" x 24"  
Height - 20"  
(Shown in Ebony Satin)



**DIGITAL BENCH**  
*MODEL J-450*  
(With Music  
Compartment)



**ORGAN BENCHES**  
*MODEL J-503*  
Size - 14" x 29"  
Height - 22"  
With Music Compartment

Available in 2 leg styles:

J-503-S Square Legs

J-503-R Round Legs

Wood Top available at additional cost.

**JANSEN®**

PAUL L. JANSEN & SON®

1550 Harrison Street • Oshkosh, WI 54901-3008 • 1-920-231-5433 • 1-800-BENCHES  
1-800-236-2437 • FAX 1-920-231-5450 • WEBSITE pljansen.com • EMAIL Customerservice@pljansen.com



## SPECIAL USE ITEMS



Size - 13" x 33"  
(Shown in Ebony Satin)

### PETITE DUET ARTIST BENCH

Height adjusts from approximately 18"-21". Features the same mechanism used in duet size artist bench on page 3. This bench is ideally suited for use in teaching studios and settings where a diamond-tufted top is not necessary.

Nine artist bench leg styles available. (see Page 2)

**Finishes Available:** Ebony, Walnut, Mahogany, or Unfinished - Satin finish is standard.

**Options (additional cost):** Hi-Polish finish, White or Ivory, Leather Upholstery



Size - 14" x 33"  
Height - 19"  
(Shown in Mahogany Satin)

### J525 SCHOOL BENCH (STRETCHER BENCH)

Extra sturdy for school use! Features a large sheet music compartment. Square legs only.



**Finishes Available:** Ebony, Walnut, Mahogany, or Unfinished - Satin finish is standard.

**Options (additional cost):** Hi-Polish, White or Ivory finish



### J50 SHEET MUSIC CABINET

Constructed with solid hardwood maple drawer fronts. Top and sides are maple veneer. Brass drawer pulls.

Cabinet Dimensions:

Height: 32"  
Width: 16"  
Depth: 14"

Drawer Dimensions:

Width: 11 1/2"  
Depth: 14 1/2"

**Finishes Available:** Ebony, Walnut, Mahogany, or Unfinished - Satin finish is standard.

**Options:** Hi-Polish available at additional cost.

# JANSEN®

PAUL L. JANSEN & SON®

1550 Harrison Street • Oshkosh, WI 54901-3008 • 1-920-231-5433 • 1-800-BENCHES  
1-800-236-2437 • FAX 1-920-231-5450 • WEBSITE pljansen.com • EMAIL Customerservice@pljansen.com

## IMPORTED BENCHES



### J850 ADJUSTABLE BENCH w/ MUSIC COMPARTMENT

- Height adjusts from approximately 18" - 22"
- Size 14" x 22"
- Available in Ebony Hi-Polish
- Black Vinyl Top
- Spade Legs
- 1" deep music compartment
- Imported



J-850  
Shown with music  
compartment open



### J820 ADJUSTABLE BENCH

- Metal Frame Construction
- Square Metal Legs
- Available in Ebony Satin
- Height adjusts from approximately 17" - 21"
- Size - 14" x 24 1/2"
- Black Vinyl Top
- Imported



### J880 HYDRAULIC BENCH

- Height adjusts from approximately 18" - 23"
- Size - 13" x 24 3/4"
- Available in Ebony Hi-Polish
- Black Fabric Top
- Imported

**JANSEN**<sup>®</sup>

PAUL L. JANSEN & SON<sup>®</sup>

1550 Harrison Street • Oshkosh, WI 54901-3008 • 1-920-231-5433 • 1-800-BENCHES  
1-800-236-2437 • FAX 1-920-231-5450 • WEBSITE pljansen.com • EMAIL Customerservice@pljansen.com

# PIANO STOOLS



## J60 WOOD TOP STOOL

Fingertip height adjustment from 16" to 23"

The J-60 features hardwood maple construction from top to bottom! Standard finishes include Ebony, Walnut, Mahogany, Unfinished or all Oak wood construction.

Shown in Ebony Satin.



## J70 UPHOLSTERED TOP STOOL

Fingertip height adjustment from 16" to 23"

Hardwood maple construction with upholstered top for added comfort! Standard finishes include Ebony, Walnut, Mahogany, Unfinished or all Oak wood construction. Shown in Walnut Satin with Brown Vinyl.



## J80 WOOD TOP CLAW FOOT STOOL

Fingertip height adjustment from 18" to 25"

The J-80 Claw Foot stool features hardwood maple construction from top to bottom!

Standard finishes include Ebony, Walnut, Mahogany, Unfinished or all Oak wood construction.

Shown in Mahogany Satin.



## J90 UPHOLSTERED TOP CLAW FOOT STOOL

Fingertip height adjustment from 17" to 24"

Hardwood maple construction with upholstered top for added comfort! Standard finishes include Ebony, Walnut, Mahogany, Unfinished or all Oak wood construction. Shown in Walnut Satin with Brown Vinyl.

### To Order:

- (1) Note the model number
- (2) Select wood type - Hardwood maple is standard.  
**Options (additional cost):** All Oak wood (Add OAK after model number.)
- (3) Select wood color and finish - Satin finish is standard.  
**Options (additional cost):** Hi-Polish
- (4) Select vinyl top upholstery color - Black, Brown, White or Ivory

# JANSEN®

PAUL L. JANSEN & SON®

1550 Harrison Street • Oshkosh, WI 54901-3008 • 1-920-231-5433 • 1-800-BENCHES  
1-800-236-2437 • FAX 1-920-231-5450 • WEBSITE pljansen.com • EMAIL Customerservice@pljansen.com

## PIANO ACCESSORIES / BENCH PADS

### Provides comfort and color to your piano bench

Manufactured by Paul L. Jansen & Son® to exacting standards with luxurious suede fabric - individually tufted. Adds color and comfort to your piano or organ bench. Polyurethane foam padding is 1" thick for extra comfort. Easily attaches to bench with tie strings. . .completely reversible. Because of our special design with a classic rolled edge, length and width measurements of bench need not be as exacting as with other bench pads.



### MANY COLORS TO CHOOSE FROM:

(as shown)

Forest Green

Rust

Sage Green

Burgundy

Beige

Red

Navy Blue

Gold

Brown

Off White

Black

### STOCK SIZES AVAILABLE

12 3/4" x 25"

14" x 25"

14" x 28"

14" x 30"

14 1/2" x 33"

14 1/2" x 35"

15 1/2" x 32"

### *CUSTOM SIZES ALSO AVAILABLE*

*\*Due to printing limitations, colors shown  
may vary from actual materials.*

**JANSEN**<sup>®</sup>

PAUL L. JANSEN & SON<sup>®</sup>

1550 Harrison Street • Oshkosh, WI 54901-3008 • 1-920-231-5433 • 1-800-BENCHES  
1-800-236-2437 • FAX 1-920-231-5450 • WEBSITE pljansen.com • EMAIL Customerservice@pljansen.com



## PIANO ACCESSORIES / CASTER CUPS



### 836 SMALL

- Hardwood Maple or Oak
- 4" Outside diameter
- 1 3/4" Inside diameter

### ORDERING HAS NEVER BEEN EASIER

- Simply note **model number**
- Select the wood species
  - Maple
  - Oak
- Select the wood color
  - Ebony
  - Walnut
  - Mahogany
  - White
  - Ivory
  - Unfinished
- Select the finish
  - Satin
  - Hi Polish



### 837 MEDIUM

- Hardwood Maple or Oak
- 5" Outside diameter
- 2 1/2" Inside diameter



### 838 LARGE

- Hardwood Maple or Oak
- 5 1/2" Outside diameter
- 3 3/8" Inside diameter



## PLASTIC CASTER CUPS

Available in:

- Clear
- Black
- White
- Brown
- 5 1/2" Outside diameter
- 1 1/2" Inside diameter

# JANSEN®

PAUL L. JANSEN & SON®

1550 Harrison Street • Oshkosh, WI 54901-3008 • 1-920-231-5433 • 1-800-BENCHES  
1-800-236-2437 • FAX 1-920-231-5450 • WEBSITE [pljansen.com](http://pljansen.com) • EMAIL [Customerservice@pljansen.com](mailto:Customerservice@pljansen.com)



## PIANO ACCESSORIES / CASTER CUPS



### J36 SMALL

- Hardwood Maple or Oak
- 3 5/8" Outside diameter
- 2 1/2" Inside diameter



### J37 MEDIUM

- Hardwood Maple or Oak
- 4 1/2" Outside diameter
- 3" Inside diameter



### J38 LARGE

- Hardwood Maple or Oak
- 5 3/4" Outside diameter
- 3 3/4" Inside diameter

#### Larger Sizes available at additional cost:

- |                           |                           |
|---------------------------|---------------------------|
| • <b>X-Large Size</b>     | • <b>XX-Large Size</b>    |
| • 6 1/2" Outside diameter | • 7 1/2" Outside diameter |
| • 4 1/2" Inside diameter  | • 5 1/2" Inside diameter  |

## LUCITE CASTER CUPS



Available in:

- Clear
- Black
- Brown
- Brass Plated
- 4 1/2" Outside diameter
- 2 3/4" Inside diameter

# JANSEN®

PAUL L. JANSEN & SON®

1550 Harrison Street • Oshkosh, WI 54901-3008 • 1-920-231-5433 • 1-800-BENCHES  
1-800-236-2437 • FAX 1-920-231-5450 • WEBSITE pljansen.com • EMAIL Customerservice@pljansen.com

# CORY CARE PRODUCTS



## Super High Gloss Polish

Specially formulated to clean and protect high gloss polyester, polyurethane and lacquer finishes in one easy step. Use Super High Gloss Polish as often as desired to eliminate fingerprints, smudging and static that attracts dust. Available in 8oz. bottle.

## All-Brite

All-Brite is a non-greasy treatment designed to polish and preserve all fine lacquered instrument surfaces. It protects against drying and cracking and is perfect for lacquered wood finishes. Use on pianos, organs, benches, and band instruments. Available in 8oz. bottle.



## Satin Sheen

Satin Sheen's remarkable cleaning and conditioning properties make maintaining any satin finish easy. Use Satin Sheen to remove fingerprints, smudges or grime. Available in 8oz. bottle.



## Buff-Brite

Buff-Brite is a high-tech, water-base buffing compound that gently removes fine scratches from all high performance finishes, including brass, silver, and nickel. Excellent for shining piano pedals too. Available in 4oz. bottle.



## Scratch-Brite

Scratch-Brite colors and repairs surface scratches on all walnut, mahogany, maple and pine instruments and furniture. It leaves surfaces polished to a smooth, high, long-lasting beautiful luster. Available in 4oz. bottle.



## Keyboard Detailer

A unique one-step cleaner/conditioner/polish designed for use on all plastic, metal, formica, wood, leather and similar synthetic surfaces. Great for synthesizers, digital pianos and digital keyboards. Available in 4oz. bottle.

## Key-Brite

Cleans, brightens and preserves all plastic, ivory and wood keyboards...even electric. Spray directly on keys and gently wipe them clean. It's completely safe on all surfaces and dissolves wax build-up. Excellent for computers too. Available in 4oz. bottle.



## Ultimate Care Kit

This Kit provides the complete care maintenance for any instrument. Each kit comes with a polisher and cleaner cloth, one 4oz. bottle of Key-Brite and your choice of one 4oz. Satin Sheen or one 4oz. Super High Gloss Polish. Options: **Hi-Polish or Satin Finish**

# JANSEN®

PAUL L. JANSEN & SON®

1550 Harrison Street • Oshkosh, WI 54901-3008 • 1-920-231-5433 • 1-800-BENCHES  
1-800-236-2437 • FAX 1-920-231-5450 • WEBSITE pljansen.com • EMAIL Customerservice@pljansen.com

# CORY CARE PRODUCTS



## Honey Oak Conditioner

The finest oak moisturizing polish and wood conditioner available. Use regularly to moisturize and protect all fine oak surfaces. Color hues have been specially added to bring out the true luster in oak grain. Apply to fine furniture, paneling, antiques and more. Available in 4oz. or 8oz. bottle.

## Natural Wood

Our #1 wood tone polish for lacquered pianos. Use regularly to moisturize and protect all finishes and open pore wood surfaces. Apply to all fine furniture, paneling, antiques and more. Use regularly to keep wood finishes looking moisturized and protected. Available in 8oz. bottle.



## Grand Piano Detailing Kit

Complete 7 Piece Cleaning Kit containing Piano Polish, Key Cleaner, Sound Board Cleaner, Pinblock Cleaning Brush, Polishing Cloth, Mega dusting Cloth, Cleaner Cloth

Options: **Hi-Polish or Satin Finish**



## Pre-Polish Finish Cleaner

An outstanding cleaner, preparing a surface for any of the Cory polishes. Use Pre-Polish to remove grime, oil, smudges, fingerprints or contaminants. Pre-Polish is a safe, water based formulation that is safe for all finishes. Available in 8oz. bottle.



## Harmony Detailing Oil

The perfect blend of moisturizing oils for all wood and metal piano surfaces. Apply to case parts, soundboards, damper heads and plates. Hand buff to high luster. Use regularly to preserve moisture and shine. Not recommended for satin or high polish finishes or use on strings or tuning parts. Available in 4oz. and 8oz. bottle.

## Coconut Cleaner

Naturally cleans all paint and wood surfaces. This cleaner is an amazing, all natural cleaner that deep cleans grime, wax, and build-up from most household surfaces. Apply directly onto surface to be cleaned, allow to soak into grime and stains before wiping. Available in 4oz. and 8oz. bottle.



# JANSEN®

PAUL L. JANSEN & SON®

1550 Harrison Street • Oshkosh, WI 54901-3008 • 1-920-231-5433 • 1-800-BENCHES  
1-800-236-2437 • FAX 1-920-231-5450 • WEBSITE pljansen.com • EMAIL Customerservice@pljansen.com

# PIANO ACCESSORIES



## WITTNER METRONOMES

Made by German Craftsmen, the Wittner metronome is an outstanding product in quality and appearance.

- Latch on cover
- Adjustable weight on pendulum
- 4 1/8" square base, 8 1/2" high

No. 1120 - Mahogany

No. 1121 - Ebony

No. 1122 - Walnut



## WITTNER TAKTELL PICCOLO

Key wound pendulum type metronome is extremely accurate and comes complete with a dust cover that protects the instrument when not in use.

A standard, multi-colored plastic metronome that measures 6" high, 2 3/4" wide and 1 3/4" deep.

No. 1125 - Mahogany

No. 1126 - Beige

No. 1127 - Ivory

No. 1128 - Black



## WITTNER SUPER-MINI TAKTELL

This metronome is the smallest and most accurate in the world. Measuring 4" high, 1 7/8" wide and 1 1/2" deep, it runs as long and conveys the beat just as reliably as other larger Wittner models. Plastic case comes in a ruby red color.

No. 1123

# JANSEN®

PAUL L. JANSEN & SON®

1550 Harrison Street • Oshkosh, WI 54901-3008 • 1-920-231-5433 • 1-800-BENCHES  
1-800-236-2437 • FAX 1-920-231-5450 • WEBSITE pljansen.com • EMAIL Customerservice@pljansen.com



# PIANO ACCESSORIES

## METAL FALLBOARD LOCK

#204 - For Acoustic Pianos

#204 M - Modified for Digital Pianos  
at additional cost.

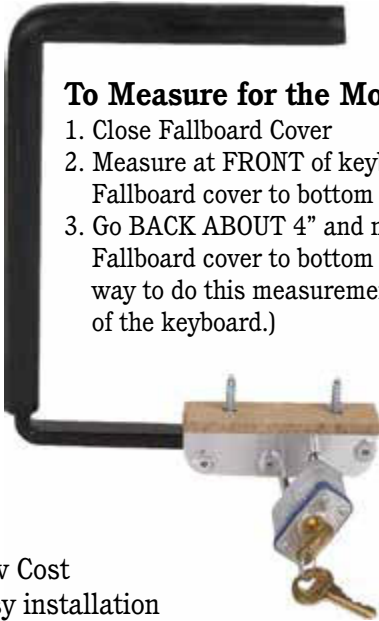

### To Measure for the Modified Lock:

1. Close Fallboard Cover
2. Measure at FRONT of keyboard - Top of Fallboard cover to bottom of keybed.
3. Go BACK ABOUT 4" and measure - Top of Fallboard cover to bottom of keybed. (Easiest way to do this measurement is from the side of the keyboard.)

- Low Cost
- Easy installation
- Includes a separate padlock
- Comes with 2 keys

## LUCITE FALLBOARD LOCK

#205

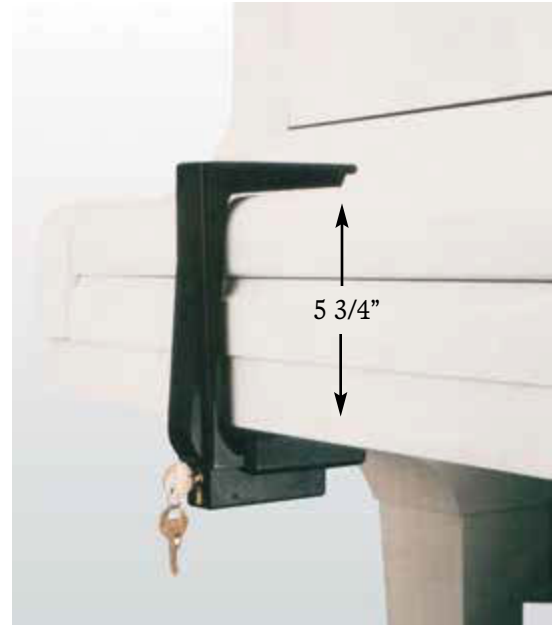

- Easy installation
- Does not touch finished surfaces of piano
- Manufactured with a high quality pin tumbler lock and two keys
- Can be keyed alike - specify with order
- Used in schools, auditoriums, hotels, churches and concert halls

## SAVE-A-RUG

Size: 9 1/2" x 12 3/4"



#202 Beige Rubber

#203 Black Rubber

Protects Carpeting. Molded in a rich, soft beige or black rubber. Blends in with any home décor.

## DELUXE SAVE-A-RUG

Size: 14" x 17"



#200 (Beige)

#201 (Black)

Plush carpeted surface, rubber back with no-fray stitched edges and decorative embroidered musical note.

# JANSEN®

PAUL L. JANSEN & SON®

1550 Harrison Street • Oshkosh, WI 54901-3008 • 1-920-231-5433 • 1-800-BENCHES  
1-800-236-2437 • FAX 1-920-231-5450 • WEBSITE pljansen.com • EMAIL Customerservice@pljansen.com



# PIANO ACCESSORIES



## PIANO SOUNDBOARD CLEANER/DUSTER

- Easily cleans between the Strings & Soundboard
- 36" - approximate overall length
- Replacement Covers Available

Piano Soundboard Cleaner / Duster is your answer to the age-old question:

*"How do I clean under the strings of my grand piano?"*

Now it's simple, just assemble the duster and slip on the plush cover. You can even use the duster for other hard to reach places. When the cover gets dirty you can wash it in your washing machine or simply replace it.

## Quiet Keys™ Vertical Piano Mute (curtain/muffler)

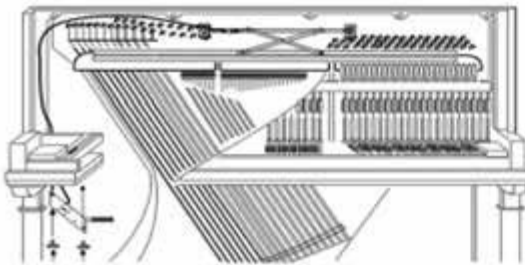

**Easy Installation!** A proven design that will compliment the very best pianos. Quiet Keys™ comes ready to install with all parts and on-off control included. When "on" acrylic felt drops between piano's hammers and strings reducing volume without affecting playability. When "off" piano functions normally.

## PIANO VOLUME CONTROL!

**Mounting to two tuning pins**  
Quiet Keys™ adjusts to fit any sized vertical piano.



- Pitch is unaffected!
- Instant removal for tuning!
- Piano finish is untouched!

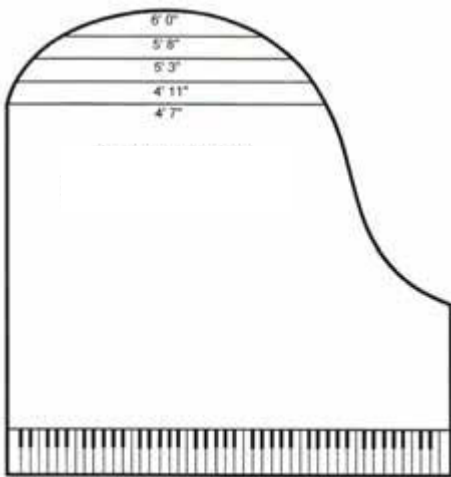

## GRAND PIANO FLOOR TEMPLATE

Trying to determine the best size Grand Piano for your home? Use the all new, all in one, **Grand Piano Floor Template**.

- Only one template needed for 5 different Grand Piano Sizes (from 4'7" to 6"0").
- Made of foldable, heavy duty brown kraft paper
- Affordable
- Re-useable
- Easy to use - Just fold at line for desired piano length!
- Minimum Order - 6

# JANSEN®

PAUL L. JANSEN & SON®

1550 Harrison Street • Oshkosh, WI 54901-3008 • 1-920-231-5433 • 1-800-BENCHES  
1-800-236-2437 • FAX 1-920-231-5450 • WEBSITE pljansen.com • EMAIL Customerservice@pljansen.com



## THE JANSEN® ARTIST BENCH REPAIR KIT

- |                  |                     |
|------------------|---------------------|
| 2 Shoulder Bolts | 4 Medium Set Screws |
| 4 Long Bushings  | 4 Small Set Screws  |
| 4 Short Bushings | Instruction Sheet   |

Repair parts are also available individually in any quantity needed.



## J4025 SHOP AND SHOWROOM DOLLIES

- Perfect for use in rebuilding and refinishing shops.
- Ideal for temporary use in piano showrooms.
- Simple installation...**Does not** require removal of grand piano casters.
- Only raises piano 5/8" off floor.
- Sold in sets of three.
- Not designed to be used in place of grand piano dollies.
- Manufactured by Paul L. Jansen & Son®

**JANSEN**<sup>®</sup>  
PAUL L. JANSEN & SON<sup>®</sup>

1550 Harrison Street • Oshkosh, WI 54901-3008 • 1-920-231-5433 • 1-800-BENCHES  
1-800-236-2437 • FAX 1-920-231-5450 • WEBSITE [pljansen.com](http://pljansen.com) • EMAIL [Customerservice@pljansen.com](mailto:Customerservice@pljansen.com)

## PIANO DOLLIES - DIGITAL



### J4004 FULLY ADJUSTABLE DIGITAL UPRIGHT DOLLY

- Standard Adjustable Model to accommodate many Digital Pianos.
- Custom Configurations for Specific Models of Digital Pianos.
  - See price list for details
- Width 47" to 68"
- Depth 15" to 22"
- Tubular Steel Construction
- Black Powder Coat Finish
- Double Wheel Rear Casters
- Single Wheel Locking Front Casters
- Manufactured by Paul L. Jansen & Son®

**Please note the instrument brand and model when ordering.**



### J4003 FULLY ADJUSTABLE DIGITAL GRAND DOLLY

Designed for pianos with casters

- Casters need to be removed from the piano before the piano is installed on the dolly.
- Manufactured by Paul L. Jansen & Son®

**JANSEN®**  
PAUL L. JANSEN & SON®

1550 Harrison Street • Oshkosh, WI 54901-3008 • 1-920-231-5433 • 1-800-BENCHES  
1-800-236-2437 • FAX 1-920-231-5450 • WEBSITE pljansen.com • EMAIL Customerservice@pljansen.com

# PIANO DOLLIES - GRANDS

## GRAND PIANO DOLLY

- **6542** - Fits Grand Pianos from 4'6" to 5'11"
- **6543** - Fits Grand Pianos from 6" to 7'6"
- *Exceptions: 6'0"/6'1" Yamaha, Kawai, Kohler & Campbell, Samick and Young Chang require the 6542.*
- **6544** - Fits Concert Grand Pianos
- **6544R** - Fits Concert Grand Pianos with large style brass casters
- **6544XL** - Fits 9'6" Bosendorfer Grand Piano
- Equipped with 5" diameter, 2" wide, American Made casters
- Standard Color - Black
- Manufactured by Paul L. Jansen & Son®
- **Options available at additional cost:**
  - **Locking casters**
  - **Brown Color**
  - **Double Truss Grand Dolly**

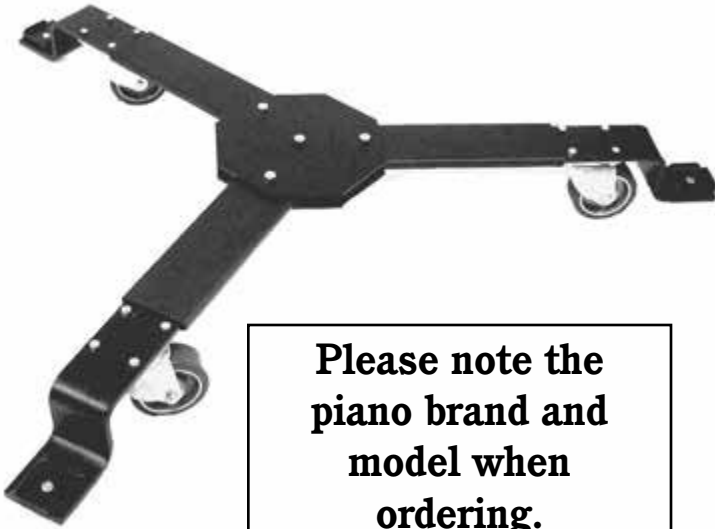

**Please note the piano brand and model when ordering.**



**J4018-S  
SQUARE**

Manufactured by  
Paul L. Jansen & Son®



**J4018-R  
ROUND**

## GRAND LEG DOLLIES

- Designed to be put under each grand piano leg
- Raises grand piano no higher than standard casters
- Equipped with American Made rubber wheel casters
- Sold in sets of 3
- Available in Black only
- Remove original piano casters before installing
- Square Dollies measure 3 1/8" x 3 1/8" I.D., 1 3/4" Deep
- Round Dollies measure 4 1/8" I.D., 1 1/2" Deep
- **For specific applications only:**
  - Recommended for Hard Surface Floors (Not Carpet)
  - Recommended for moving pianos short distances
  - Recommended for moving pianos within a room
  - Recommended for grand pianos under 6'
  - Not to be used in place of a Grand Piano Dolly
  - Not recommended for schools
  - Not recommended for stage applications

**JANSEN®**  
PAUL L. JANSEN & SON®

1550 Harrison Street • Oshkosh, WI 54901-3008 • 1-920-231-5433 • 1-800-BENCHES  
1-800-236-2437 • FAX 1-920-231-5450 • WEBSITE pljansen.com • EMAIL Customerservice@pljansen.com

## PIANO DOLLIES - UPRIGHT

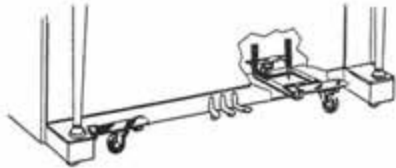

### J4009 STANDARD DUTY UPRIGHT DOLLIES

- Excellent for use in schools, showrooms, churches, etc.
- Accommodates pianos up to 14 1/2" in depth.
- Requires 32" doorway to exit.
- Projects piano 4" away from wall.
- Raises piano only 3/4" off the floor.
- Locking wheels not available on this model.
- Shipping weight 24 lbs.
- 2 1/2" American made casters work best on smooth surfaces.
- Heavy-duty frame construction gives years of trouble-free service.
- Manufactured by Paul L. Jansen & Son®

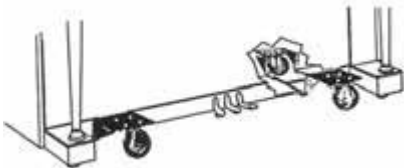
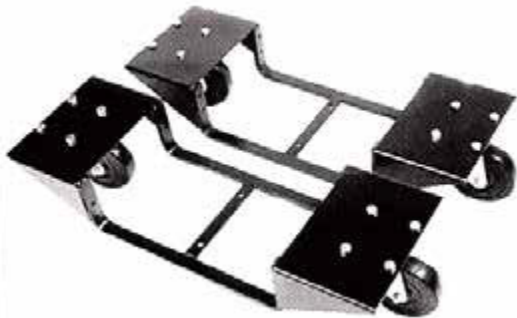

### J4010 HEAVY DUTY UPRIGHT DOLLIES

- Designed to easily move heavy studio and upright pianos.
- Accommodates pianos up to 14" in depth.
- Custom Dollies available for larger depth pianos.
- Requires 36" doorway to exit.
- Projects piano 7" away from wall.
- Raises piano only 3/4" off the floor.
- Shipping weight 45 lbs.
- 5" Ball Bearing American Made Casters roll over carpet and thresholds.
- Heavy-duty frame construction gives years of trouble-free service.
- Manufactured by Paul L. Jansen & Son®
- **Options available at additional cost:**
  - **Locking casters**



### 6545 SPINET & CONSOLE DOLLY

- Adjustable Width from 46 1/2" to 61 1/2"
- Adjustable Depth from 17 3/4" to 30"
- Designed to support pianos with free standing front legs
- Made of Tubular Steel
- 3 1/2" Diameter, 1 1/4" Wide American Made Casters
- Standard Color - Black
- Manufactured by Paul L. Jansen & Son®
- **Options available at additional cost:**
  - **Locking casters**
  - **Brown Color**

**JANSEN®**

PAUL L. JANSEN & SON®

1550 Harrison Street • Oshkosh, WI 54901-3008 • 1-920-231-5433 • 1-800-BENCHES  
1-800-236-2437 • FAX 1-920-231-5450 • WEBSITE pljansen.com • EMAIL Customerservice@pljansen.com



# PIANO COVERS - UPRIGHT/ORGAN COVERS

## SPINET & CONSOLE, STUDIO & UPRIGHT COVERS

*Available in Black or Dark Brown Mackintosh*

### Spinet & Console Covers

3'0" Spinet  
3'4" Console



### Studio & Upright Covers

3'7"  
3'8"  
3'10"  
4'0"  
4'2"  
4'4"  
4'6"  
4'8"  
4'10"

## ORGAN COVERS

*Available in Black or Dark Brown Mackintosh*

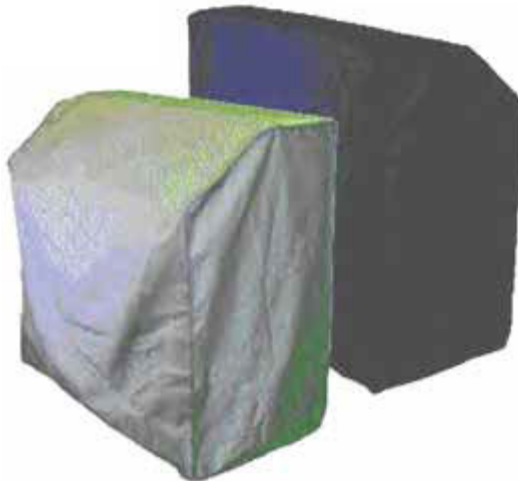

### Many Patterns available including:

- Baldwin Organ Covers
- Conn Organ Covers
- Hammond Organ Covers
- Lowrey Organ Covers

Custom Organ Covers Available  
Call for more information and pricing

## BLACK COTTON PADDED ORGAN COVERS

		<u>Width</u>	<u>Depth</u>	<u>Height</u>
<b>J852</b>	Spinet model organs	46"	27"	34"
<b>J853</b>	Console full pedal organs (B-3)	49"	30"	38"
<b>J854</b>	Concert size organs	57"	30"	40"
<b>J855</b>	Pedalboard cover	33"	44"	6"

# JANSEN®

PAUL L. JANSEN & SON®

1550 Harrison Street • Oshkosh, WI 54901-3008 • 1-920-231-5433 • 1-800-BENCHES  
1-800-236-2437 • FAX 1-920-231-5450 • WEBSITE pljansen.com • EMAIL Customerservice@pljansen.com

# PIANO COVERS - GRAND & DIGITAL



## GRAND PIANO COVERS

- Available in Black or Dark Brown Mackintosh
- Available in Black or Dark Brown Vinyl
- All covers come with slits
- Locking Straps available at additional cost
- See price pages for a selection of Models and Sizes
- Vast selection of patterns available, too many to list!

We use the highest quality materials and craftsmanship, these grand piano covers are custom manufactured to fit any make and model piano.

Select your brand of piano from the choices listed in the price pages.

If you do not see your piano listed, please call and we will check our library to see if it is available.

We have a wide selection of materials for you to choose from, including Mackintosh, Vinyl, Nylon Padded and Cotton Padded.

---

### **MACKINTOSH:**

Mackintosh is woven non-cotton material bonded to a soft lining. Mackintosh is an attractive and popular fabric, as it has a softer and warmer look to it than the vinyl. Exceptionally tough and durable and well suited for use in schools, churches, theaters and studios. Mackintosh is thicker than vinyl, and offers more protection from bumps and scratches.

### **VINYL:**

Vinyl is heavy leatherette, bonded to a soft fleecy backing. We use a thick, furniture-grade quality vinyl, not a paper-thin vinyl that looks like plastic. Can be dusted easily, wiped with a damp cloth, or vacuumed.



---

## DIGITAL PIANO COVERS UPRIGHT & GRAND

- Available in Black or Dark Brown Mackintosh
- Available in Black or Brown Vinyl
- Available in Short Drop and Full Drop
- Digital Grand Covers are also available
- Call with make, model, width, depth and height of digital piano

# JANSEN®

PAUL L. JANSEN & SON®

1550 Harrison Street • Oshkosh, WI 54901-3008 • 1-920-231-5433 • 1-800-BENCHES  
1-800-236-2437 • FAX 1-920-231-5450 • WEBSITE [pljansen.com](http://pljansen.com) • EMAIL [Customerservice@pljansen.com](mailto:Customerservice@pljansen.com)

## PIANO COVERS - PADDED



### J48A BLACK COTTON PADDED COVERS FOR GRAND PIANOS

- Heavy Duty
- Close-Weave Duck Cover
- Cotton Filling
- Flannel Lined
- 4" Quilted Squares
- See the price pages for specific sizes
- **Options available at additional cost:**
  - Locking Straps, Side Slits, Full Drop



### J58N BLACK NYLON PADDED COVERS FOR GRAND PIANOS

- Lightweight
- Nylon Cover
- Polyester Filling
- Polyester Lined
- 4" Quilted Squares
- See the price pages for specific sizes
- **Options available at additional cost:**
  - Locking Straps, Side Slits, Full Drop



### BLACK COTTON PADDED COVERS FOR SPINET, CONSOLE, STUDIO & UPRIGHT PIANOS

- Heavy Duty
- Close-Weave Duck Cover
- Cotton Filling
- Flannel Lined
- 4" Quilted Squares
- See the price pages for specific Models and Sizes
- **Options available at additional cost:**
  - Locking Straps

**JANSEN**<sup>®</sup>

PAUL L. JANSEN & SON<sup>®</sup>

1550 Harrison Street • Oshkosh, WI 54901-3008 • 1-920-231-5433 • 1-800-BENCHES  
1-800-236-2437 • FAX 1-920-231-5450 • WEBSITE pljansen.com • EMAIL Customerservice@pljansen.com

## VERTICAL PIANO CLIMATE CONTROL SYSTEMS

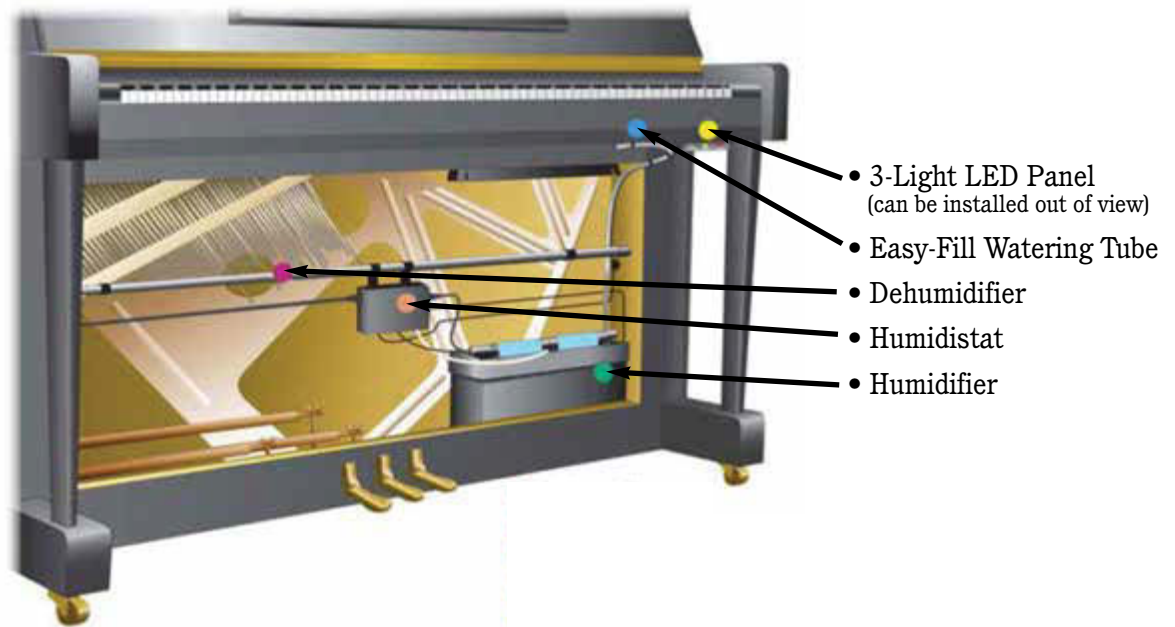

**SEE PRICE PAGES FOR COMPLETE LISTING OF VERTICAL SYSTEMS AND PARTS**

Model No.	Vertical Piano Systems
5PS 38	5-Part System with H-5 Humidistat, one extendible 36-inch, 38-watt Dehumidifier, and one Universal Tank Humidifier with Smart Bracket.
5PS 50	5-Part System with H-5 Humidistat, one extendible 48-inch, 50-watt Dehumidifier, and one Universal Tank Humidifier with Smart Bracket. <b>Our Recommended choice for most vertical pianos</b>
BSV8PS	Backside Vertical 8-Part System includes H-5 Humidistat, four 18-inch, 18-watt Dehumidifiers and two Humidifiers to be installed in the back of the piano. Acoustic cloth back cover included. This system has one Smart Bracket.



**Model HG-W**

### HYGROMETER / THERMOMETER

- Easy to operate / fast response time.
- Displays Temperature in Fahrenheit or Celsius.
- Displays Maximum, Minimum and Current Temperature and humidity readings with the touch of a button.
- Self-standing or wall mountable.
- Read-outs in large symbols
- 1 AAA 1.5 volt battery included
- 2 3/4" Width, 4" Length, 1" Depth
- This is not a Damp-Chaser® product

**Call for availability.**

# JANSEN®

PAUL L. JANSEN & SON®

1550 Harrison Street • Oshkosh, WI 54901-3008 • 1-920-231-5433 • 1-800-BENCHES  
1-800-236-2437 • FAX 1-920-231-5450 • WEBSITE pljansen.com • EMAIL Customerservice@pljansen.com

**GRAND PIANO CLIMATE CONTROL SYSTEMS**

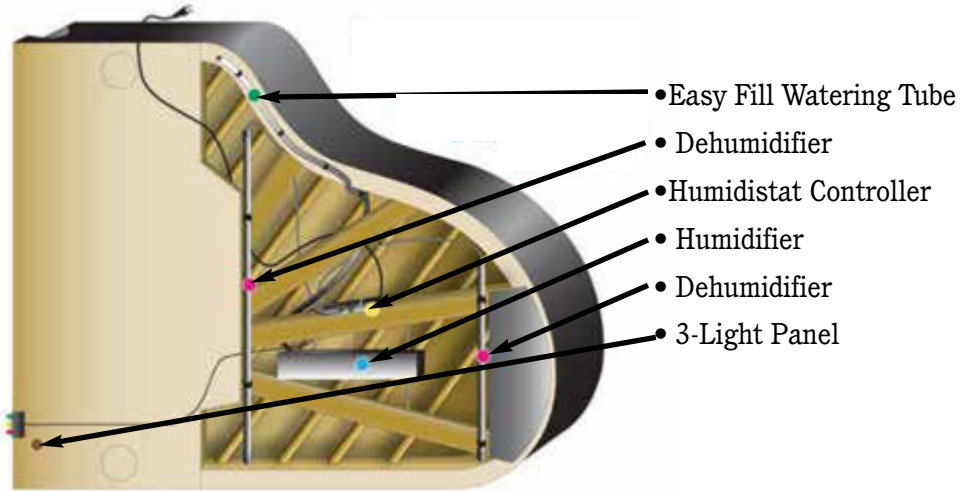

The Piano Life Saver System as seen from beneath a Grand Piano.

**SEE PRICE PAGES FOR COMPLETE LISTING OF VERTICAL SYSTEMS AND PARTS**

Model No.	Grand Piano Systems
G6PS 38	Grand 6-Part System with H-5 Humidistat, one 36-inch, 38-watt primary dehumidifier, one 24-inch, 25-watt secondary Dehumidifier, and a Universal Tank Humidifier with Smart Bracket. <b>This system fits all grand pianos.</b>
G6PS 50	Grand 6-Part System with H-5 Humidistat, one 48-inch, 50-watt primary dehumidifier, one 24-inch, 25-watt secondary Dehumidifier, and a Universal Tank Humidifier with Smart Bracket.
G7PS 38	Grand 7-Part System with H-5 Humidistat, one 36-inch, 38-watt primary dehumidifier, one 24-inch, 25-watt secondary Dehumidifier, and two Universal Tank Humidifiers with one Smart Bracket.
G7PS 50	Grand 7-Part System with H-5 Humidistat, one 48-inch, 50-watt primary dehumidifier, one 24-inch, 25-watt secondary Dehumidifier, and two Universal Tank Humidifiers with one Smart Bracket.

Dampp-Chaser® Humidifier Treatment was formulated to minimize bacterial and algae growth in the Humidifier tank and watering tube, by adding 1/2 capful of Humidifier Treatment to each can of water, the piano owner can prolong Humidifier pad life, keep the watering tube clear and reduce mineral build-up on the pads and in the tank.

Available in 7.5oz and 16oz. bottles.



**UHP 4**  
The 4-Pack comes with 1 black liner, 1 clear liner, and 4 clean sleeves

**UHP 48**  
The 48 pack is your best value. Comes with 12 clean sleeves.



Please check the price sheet under Humidifier supplies for other supplies related to the humidifier. Watering cans and fill tubes can be purchased separately.





# MOVING EQUIPMENT

## DUAL TRUCKS

**Deliveries using only one man!**

Instantaneous control at your fingertips. Spring-loaded plunger allows swivel wheels to be locked for one-man operation or swivel in unlocked position for two-man operation.



***When ordering specify base size:***

**23" x 5"** Angle base (for pianos and organs)

**28" x 4"** Angle base for Hammond B3

Dual trucks with swivel caster locks and four 7-foot web straps included. Shipping weight 55 lbs.

***Replacement straps available:***

- 1 set of 4 web straps 7'
- 1 set of 4 web straps 8'
- 1 set of 4 web straps 10'

Place one truck at each end of the load, fasten straps and press foot-lever at each end to raise load for moving. Handles fold out of the way when not in use. Uses four straps to hold piano or organ securely.

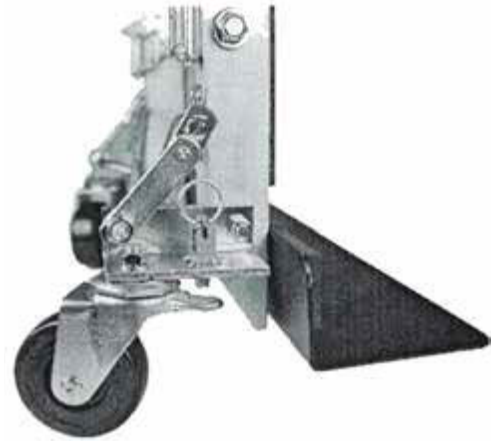

No clumsy thumbscrews to lose, bent or damaged threads becoming inoperable.

Always working, easy to use, foolproof, fingertip operated spring-loaded swivel caster locking mechanism.

Castors "fully retract" off the floor to allow piano or organ to rest on its own weight. Will not skid or roll while traveling.



# JANSEN®

PAUL L. JANSEN & SON®

1550 Harrison Street • Oshkosh, WI 54901-3008 • 1-920-231-5433 • 1-800-BENCHES  
1-800-236-2437 • FAX 1-920-231-5450 • WEBSITE pljansen.com • EMAIL Customerservice@pljansen.com

## GRAND TRANSPORTER®

- One Man Operation
- Heavy Duty
- Will Lift 3000 lbs.
- Folds for easy storage

Will lift and move any size grand piano.

In less than one minute one person can position GRAND TRANSPORTER® under the grand piano to lift the piano off the floor to move the piano.

GRAND TRANSPORTER® folds for easy storage and for moving from place to place.

GRAND TRANSPORTER® sits over a Grand Piano Dolly and lifts the piano to install or remove the Grand Piano Dolly.

DESIGNED AND BUILT IN AMERICA  
(PATENT PENDING)

**JANSEN®**  
PAUL L. JANSEN & SON®

1550 Harrison Street • Oshkosh, WI 54901-3008 • 1-920-231-5433 • 1-800-BENCHES  
1-800-236-2437 • FAX 1-920-231-5450 • WEBSITE pljansen.com • EMAIL Customerservice@pljansen.com

## MOVING EQUIPMENT

### J250 MOVING DOLLY



- Pianos and organs won't slide off our "No-Slip" dollies
- Rubber ends grip pianos and organs to hold them securely to the dolly
- Sturdily constructed of hardwood Maple with mortised frame ends bolted together to keep dolly square
- Features 4" swivel, non-marking, ball bearing, rubber casters
- Length 30"
- Width 18"
- Height 7 1/2"
- Replacement sets of 4 swivel casters or rubber end caps can be ordered
- Manufactured by Paul L. Jansen & Son®

### DPD DIGITAL PIANO MOVING DOLLY



- Moves Digital pianos the easy way and without damage
- Fully carpeted
- 4" swivel, non-marking, ball bearing, rubber casters
- Length 59"
- Width 19"
- Manufactured by Paul L. Jansen & Son®

**JANSEN**®

PAUL L. JANSEN & SON®

1550 Harrison Street • Oshkosh, WI 54901-3008 • 1-920-231-5433 • 1-800-BENCHES  
1-800-236-2437 • FAX 1-920-231-5450 • WEBSITE [pljansen.com](http://pljansen.com) • EMAIL [Customerservice@pljansen.com](mailto:Customerservice@pljansen.com)

## MOVING ACCESSORIES

### GRAND PIANO SKIDBOARDS

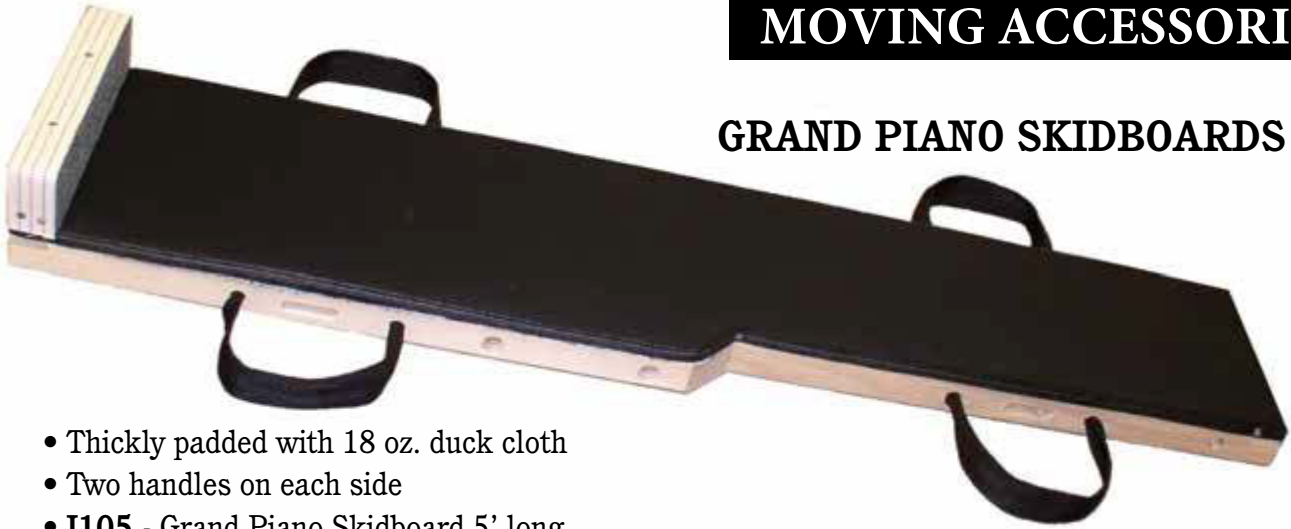

- Thickly padded with 18 oz. duck cloth
- Two handles on each side
- **J105** - Grand Piano Skidboard 5' long
- **J106** - Grand Piano Skidboard 6' long
- **J107** - Grand Piano Skidboard 7' long
- **J109** - Grand Piano Skidboard 9' long
- **Custom lengths** - Available upon request
- Web straps sold separately
- Manufactured by Paul L. Jansen & Son®



### J1360 MOVING PADS

- 72" X 80"
- Economically priced
- Valuable protection



### WEB STRAPS

- 2 inch wide web straps
- Extra strength, positive-locking roller buckles
- **J112** - 12' Long (per pair)
- **J115** - 15' Long (per pair)
- **J120** - 20' Long (per pair)

**JANSEN**®

PAUL L. JANSEN & SON®

1550 Harrison Street • Oshkosh, WI 54901-3008 • 1-920-231-5433 • 1-800-BENCHES  
1-800-236-2437 • FAX 1-920-231-5450 • WEBSITE [pljansen.com](http://pljansen.com) • EMAIL [Customerservice@pljansen.com](mailto:Customerservice@pljansen.com)

# PIANO LIFTING EQUIPMENT

## PIANO LIFTING BARS

Two lengths available:

PLB-28 28"

PLB-48 48"



PLB-28



PLB-48

- One person operation
- 28" bar facilitates easy installation of caster cups under a vertical piano
- Eases installation of blocking to assist in the installation of upright piano dollies
- 48" bar facilitates easy installation of caster cups under a grand piano
- Manufactured by Paul L. Jansen & Son®

## JACK-IN-THE-BOX



Designed for raising one Grand Piano leg at a time so you can remove or replace a piano caster, or install caster cups. The box comes complete with hydraulic jack mounted inside and has ample storage space for extra caster cups and tools.

To lift the piano, position box next to leg to be raised, then elevate piano by pumping the handle of the jack.

Includes a carrying handle and rubber feet to protect box when handling. The jack extends 5" above box.

Box measures: Height: 21", Width: 7", Depth: 7 1/2"

Manufactured by Paul L. Jansen & Son®

## GRAND LEG STAND



Designed especially to support grand pianos during leg removal and/or caster repair or replacement.

Height: 26 1/2"

Weight: 6 lbs

Manufactured by Paul L. Jansen & Son®

# JANSEN®

PAUL L. JANSEN & SON®

1550 Harrison Street • Oshkosh, WI 54901-3008 • 1-920-231-5433 • 1-800-BENCHES  
1-800-236-2437 • FAX 1-920-231-5450 • WEBSITE pljansen.com • EMAIL Customerservice@pljansen.com



# FAX ORDER FORM

**PAUL L. JANSEN & SON**® • 1550 Harrison Street • Oshkosh, WI 54901-3008  
 PHONE 1-920-231-5433 • 1-800-236-2437 • WEBSITE: www.pljansen.com • E-MAIL: customerservice@pljansen.com  
 FAX ORDERS 24 HOURS A DAY, 7 DAYS A WEEK • FAX 1-920-231-5450

**BILLING INFORMATION**

CUSTOMER ID #: \_\_\_\_\_ PO#: \_\_\_\_\_ DATE: \_\_\_\_\_  
 COMPANY NAME: \_\_\_\_\_ ORDERED BY: \_\_\_\_\_  
 ADDRESS: \_\_\_\_\_  
 CITY: \_\_\_\_\_ STATE: \_\_\_\_\_ ZIP: \_\_\_\_\_  
 PHONE: \_\_\_\_\_ FAX: \_\_\_\_\_

**SHIPPING INFORMATION** (If different than above information)

SHIP TO: \_\_\_\_\_  
 ADDRESS: \_\_\_\_\_  
 CITY: \_\_\_\_\_ STATE: \_\_\_\_\_ ZIP: \_\_\_\_\_  
 PHONE: \_\_\_\_\_ E-MAIL: \_\_\_\_\_

QTY.	DESCRIPTION (Size, Color, Model Number, etc.)
	<b>IMPORTANT REMINDER:</b> If you order a piano dolly or piano cover, please indicate the size, brand name and model of the piano. Also indicate if you want locking wheels or locking straps.

OPEN ACCT.  
  MC  
  DISCOVER  
  VISA  
  AMEX  
  COD

--	--	--	--	--	--	--	--	--	--	--	--	--	--	--	--	--	--	--	--

Expiration Date: \_\_\_\_\_ Name (on card): \_\_\_\_\_